

Kreatech™ FISH probes

Product Information Sheet

KBI-40006

RB1 (13q14)/RCAN1 (21q22), SE X (DXZ1) / SE
Y (DYZ3) / SE 18 (D18Z1)

IVD

CE 0344

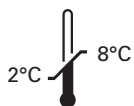

Kreatech Biotechnology B.V.
Vierweg 20
1032 LG Amsterdam
The Netherlands
www.LeicaBiosystems.com

PI-KBI-40006_D2.0

Published February 2019

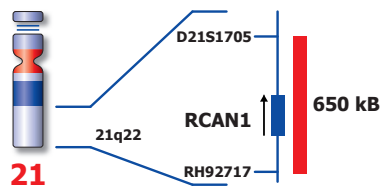
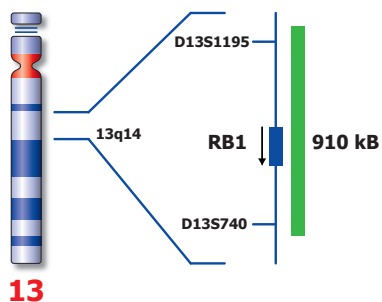

Not to scale

Kreatech™ RB1 (13q14)/RCAN1 (21q22), SE X (DXZ1) / SE Y (DYZ3) / SE 18 (D18Z1) FISH probes

Introduction:

Trisomy 21 is one of the most common chromosomal abnormalities in live born children and causes Down syndrome, a particular combination of phenotypic features that includes mental retardation and characteristic facies. Molecular analysis has revealed that the 21q22.1-q22.3 region appears to contain the gene(s) responsible for the congenital heart disease observed in Down syndrome.

Trisomy 13, also called Patau syndrome, is a chromosomal condition that is associated with severe mental retardation and certain physical abnormalities. The critical region has been reported to include 13q14-13q32 with variable expression, gene interactions, or interchromosomal effects. **Trisomy 18** causing Edwards syndrome is the second most common autosomal trisomy after trisomy 21. The disorder/condition is characterized by severe psychomotor and growth retardation, microcephaly, microphthalmia, malformed ears, micrognathia or retrognathia, microstomia, distinctively clenched fingers, and other congenital malformations. Chromosomal abnormalities involving the X and Y chromosome (sex chromosomes) are slightly less common than autosomal abnormalities and are usually much less severe in their effects. The high frequency of people with sex chromosome aberrations is partly due to the fact that they are rarely lethal conditions. **Turner syndrome** occurs when females inherit only one X chromosome; their genotype is X0. **Metafemales** or triple-X females, inherit three X chromosomes; their genotype is XXX or more rarely XXXX or XXXXX. **Klinefelter syndrome** males inherit one or more extra X chromosomes; their genotype is XXY or more rarely XXXY, XXXXY, or XY/XXY mosaic. **XYY syndrome** males inherit an extra Y chromosome; their genotype is XYY.

Intended use:

The **RCAN1 (21q22) specific** FISH probe is optimized to detect copy of numbers of chromosome 21 at 21q22 on uncultured amniotic cells.

The **RB1 (13q14) specific** FISH probe is optimized to detect copy of numbers of chromosome 13 at 13q14 on uncultured amniotic cells.

The **SE 18 (D18Z1) (Satellite Enumeration)** FISH probe is optimized to detect copy of numbers of chromosome 18 at 18p11-18q11 on uncultured amniotic cells.

The **SE X (DXZ1)** FISH probe is optimized to detect copy of numbers of chromosome X at Xp11-Xq11 on uncultured amniotic cells.

The **SE Y (DYZ3)** FISH probe is optimized to detect copy of numbers of chromosome Y at Yp11-Yq11 on uncultured amniotic cells.

Vial 1

Critical region 1 (red):

The **21q22 specific** FISH probe is direct-labeled with PlatinumBright™550.

Critical region 2 (green):

The **13q14 specific** FISH probe is direct-labeled with PlatinumBright™495.

Vial 2

Critical region 3 (blue):

The **SE 18** FISH probe is direct-labeled with PlatinumBright™415.

Critical region 4 (green):

The **SE X** FISH probe is direct-labeled with PlatinumBright™495.

Critical region 5 (red):

The **SE Y** FISH probe is direct-labeled with PlatinumBright™550.

Please refer to the Instructions for Use for the entire Kreatech FISH protocol.

Kreatech FISH probes are REPEAT-FREE™ and therefore do not contain Cot-1 DNA. Hybridization efficiency is increased and background, due to unspecific binding, is highly reduced.

Interpretation:

The **RB1 (13q14)/RCAN1 (21q22)** FISH probe is designed as a dual-color assay to detect gains of chromosome 21 and 13. Trisomy 21 will be detected by three red signal at the 21q22 region and two green signals for chromosome 13 (3R2G). Trisomy 13 will be detected by 3 green signals at the 13q14 region and two red signals for chromosome 21 (2R3G). Two single color red and green signals will identify the normal chromosomes 13 and 21 (2R2G).

The **SE X (DXZ1) / SE Y (DYZ3) / SE 18 (D18Z1) specific** FISH probe is designed as a triple color assay to detect gains or losses of chromosome X, Y and/or 18. Two single green signals will identify the normal X chromosomes in females (2G). One green and one red signal will identify the normal X and Y chromosomes in males (1R1G). Trisomy 18 will be detected by three blue signals for chromosome 18 (3B). Two single blue signals will identify the normal chromosome 18 (2B).

Expected Signals Using	Normal Signal Pattern		Trisomy 21	Trisomy 13	Trisomy 18	
13/21	2R2G		3R2G	2R3G		
	Female	Male			Female	Male
X/Y + 18	2G2B	1R1G2B			2G3B	1R1G3B

References:

Korenberg J. et al, 1994, Proc. Nat. Acad. Sci. 91: 4997-5001

Spathas D et al, 1994, Prenat Diagn. 14(11): 1049-1054

Tepperberg et al, 2001, Prenat Diagn 21(4): 293-301

Warning and precautions: In case of emergencies check SDS sheets for medical advice. SDS sheets may be obtained by either contacting Leica Technical Support or visiting www.LeicaBiosystems.com. DNA probes contain formalin which is a teratogen; do not inhale or allow skin contact. Wear gloves and a lab coat when handling DNA probes. All materials should be disposed of according to your institution's guidelines for hospital waste disposal.

Reagent Storage and Handling:

Store at 2-8 °C. Reagents should not be used after the expiration date on the vial label.

TECHNICAL SUPPORT

Technical support is available at www.LeicaBiosystems.com or +31 20 6919181

or via e-mail: kreatech-support@leicabiosystems.com.

CUSTOMER SERVICE

Kreatech probes may be ordered through Leica Customer Service +31 20 6919181 or order via e-mail:

purchase.orders@leica-microsystems.com.